



**MAGNA™**

*Industrial Performance*





## **MAGNA – quality and performance**

For decades, MAGNA has been a familiar name to professionals worldwide in the field of screwdriver bits. As a leading supplier of screwdriver bits for demanding users in industrial production, MAGNA offers bits which combine high performance with excellent service life. Modern production methods ensure that MAGNA screwdriver bits are manufactured to a consistently high quality level.

### **User focus**

With our optimum production processes for all bit types, we are able to meet user requirements and offer first-class quality.

By choosing MAGNA, you will always make the right choice; the right screwdriver bit for every conventional type of screw, at the required hardness level, with the appropriate drive dimension.



**Four types for all applications**

The **MAGNA** range of screwdriver bits comprises four different qualities of bit.

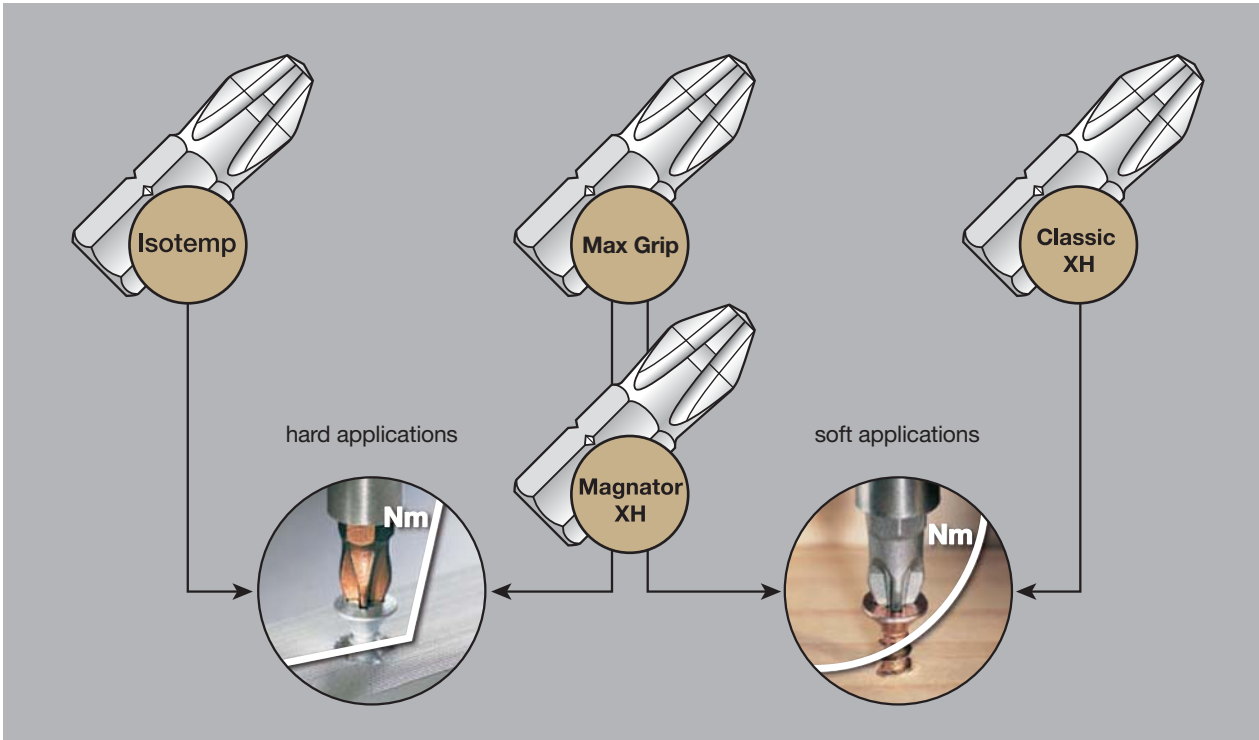

The **Classic XH bits** are particularly suitable for ‘soft screwdriving’ applications, where the torque load gradually increases as the screw enters the material.



The **Isotemp bits** are ideal for ‘hard screwdriving’ applications, where sudden torque loads can lead to excessive strain within a bit. Isotemp bits undergo a special tempering process, resulting in a high resistance to breakage and abrasion. This ensures a long service life for the bit.



The **Magnator bits** are the ‘generalist’ bits within the range. The integrated torsion zone geometry is designed to manage the torque peaks that sometime occur whilst screwdriving, thereby reducing the risk of bit failure.



The **Max Grip bits** combine excellent grip with long life. The surface of the bit is roughened to create more grip in the screw and then coated with titanium nitride (TiN) to protect against abrasion.

All bits with torsion zone are denoted by "+" in catalogue (e.g. Max Grip+, Magnator XH+ versions).

### Innovation through combination

The **Max Grip** bit from **MAGNA** combines excellent grip in the screw head with long life. Made from particularly high-quality tempered tool steel, the surface is roughened to increase the grip and then coated with titanium nitride (TiN) for a long service life. The titanium nitride coating prevents a smoothing out of the roughened surface and at the same time, reduces wear.

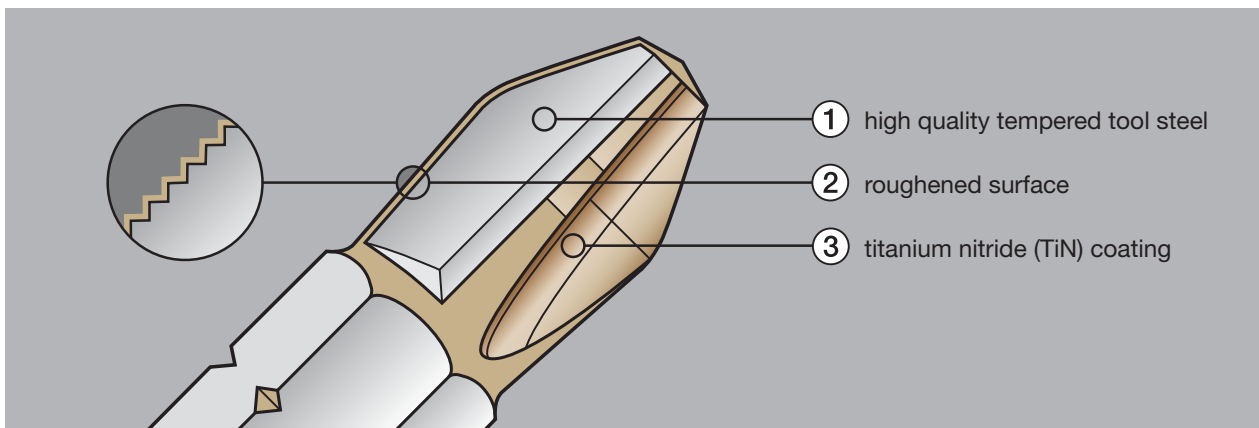

The result of this process is a particularly durable, highly adhesive bit which becomes fixed in the screw head without damaging it. In addition, the **Max Grip** bit has an optimized geometry for a perfect fit in the screw head and a torsion zone to protect against breakage during torque peaks.

### Anti-Camout behaviour and long service life

For the first time, **Max Grip** offers a bit that combines outstanding anti-camout behaviour with a long service life. The chart shows comparative anti-camout behaviour vs. service life of ① diamond coated bits, ② standard TiN coated bits and ③ conventional bits.

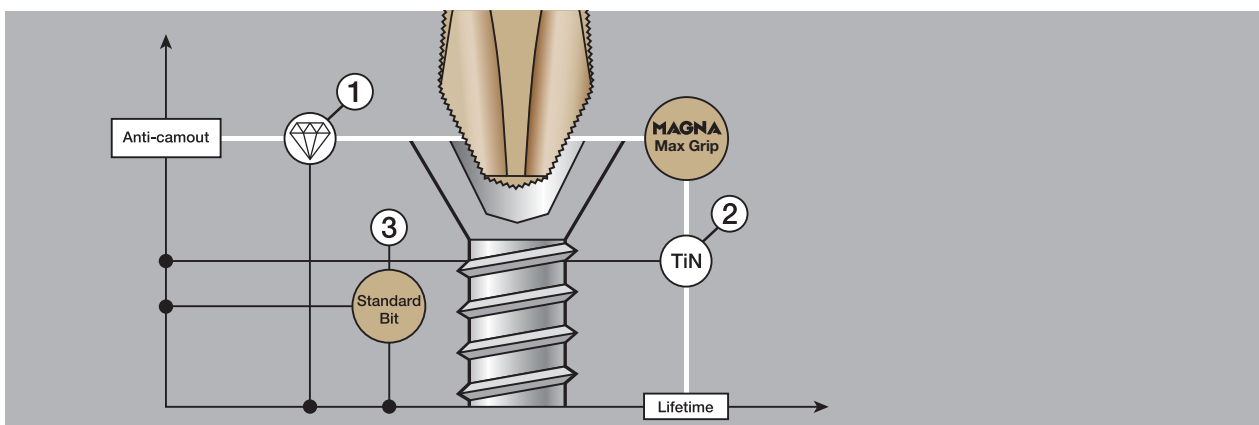

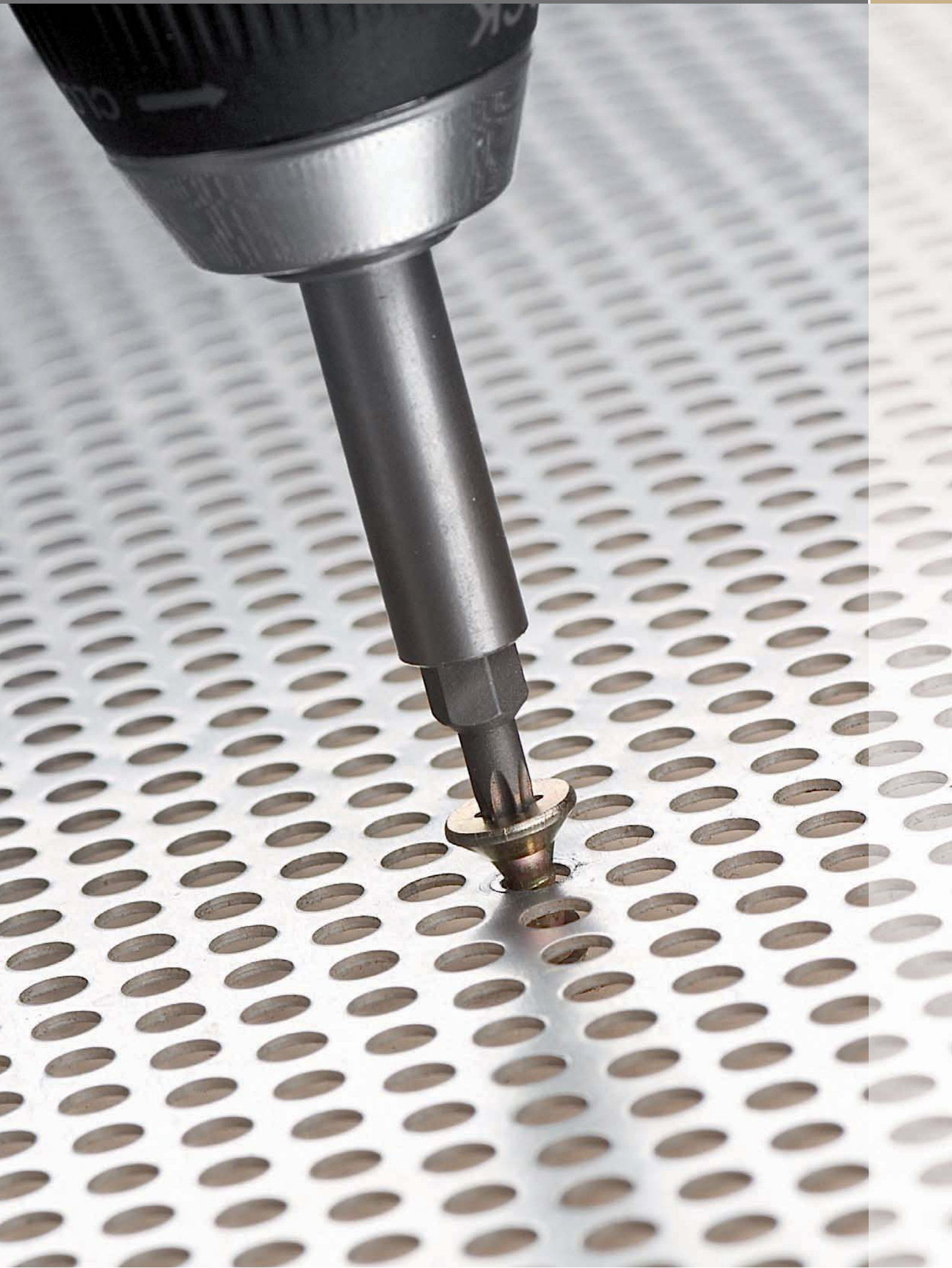

Contents

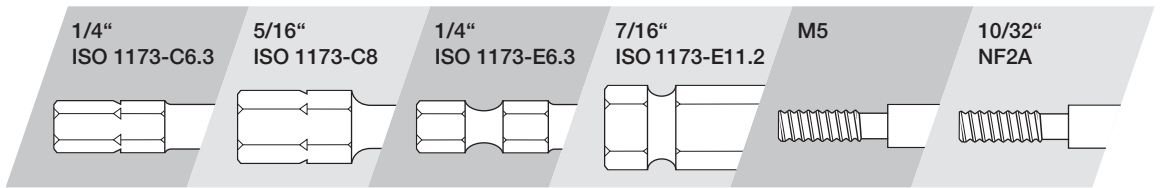

<b>PZ</b> Pozidriv	Pages 7/8	Page 9	Pages 8/9	–	Page 9	Page 9
<b>PH</b> Phillips	Pages 10/11	Page 13	Pages 11/12/13	–	Page 13	Page 13
<b>T</b> Torx®	Page 14	Page 16	Pages 14/15/16	–	–	–
<b>TW</b> Torxalign® (Wedge)	Page 16	–	Page 16	–	–	–
<b>TH</b> Torx® Tamper Resistant	Page 17	–	–	–	–	–
<b>LS</b> Slotted	Page 18	Page 19	Page 19	–	–	–
<b>SW</b> Hex	Page 20	Page 20	Page 20	–	–	–
<b>R</b> Square	Page 21	–	Page 21	–	–	–
<b>TQ</b> Torq-Set®	Page 22	Page 22	Page 22	Page 23	–	–
<b>TW</b> Tri-Wing®	Page 23	–	Page 23	–	–	–
<b>SP</b> Spanner	Page 23	–	–	–	–	–
<b>Double-Ended Bits</b>	Page 24	–	–	–	–	–

<b>Bit Holders</b>	Pages 25 / 26
<b>Nutsetters</b>	Pages 27 / 28
<b>Sockets</b>	Page 28
<b>Extensions</b>	Page 29
<b>Screwdrivers</b>	Page 29

Torx® and Torxalign® are registered trademarks of Acument Intellectual Properties, LLC. Pozidriv is a registered trademark of European Industrial Services Ltd. Torq-Set® and Tri-Wing® are registered trademarks of Phillips Screw Company.

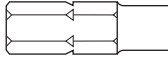

Tip	Length mm	Part number F00Y...	Sales Package qty.	Despatch package qty.	Barcode
-----	-----------	---------------------	--------------------	-----------------------	---------

Drive ISO 1173-C6.3, 1/4" external hex shank

Classic XH version

Pz0	25	221684	10	3	4014468058110
Pz1	25	216571	10	3	4014468056406
Pz1	25	224641	100	1	4014468064227
Pz2	25	216573	10	3	4014468056413
Pz2	25	224642	100	1	4014468064234
Pz3	25	216575	10	3	4014468056420
Pz3	25	224643	100	1	4014468064241
Pz4	32	221691	5	3	4014468058189

Max Grip+ version

Pz1	25	221692	10	3	4014468058196
Pz2	25	221693	10	3	4014468058202
Pz2	25	221694	100	1	4014468058219
Pz3	25	221695	10	3	4014468058226

Isotemp version

Pz1	25	217176	10	3	4014468056499
Pz1	25	221697	100	1	4014468059674
Pz2	25	217177	10	3	4014468056505
Pz2	25	221699	100	1	4014468059681
Pz3	25	217216	10	3	4014468056512
Pz3	25	221701	100	1	4014468059698

Magnator XH+ version

Pz1	25	221685	10	3	4014468058127
Pz1	25	221686	100	1	4014468058134
Pz2	25	221687	10	3	4014468058141
Pz2	25	221688	100	1	4014468058158
Pz3	25	221689	10	3	4014468058165
Pz3	25	221690	100	1	4014468058172



Drive ISO 1173-C6.3, 1/4" external hex shank, with ribbed bit surface

Classic XH version

Pz1	25	216765	10	3	4014468056468
Pz2	25	216766	10	3	4014468056475
Pz2	25	221705	100	1	4014468059766
Pz3	25	216767	10	3	4014468056482

Isotemp version

Pz1	25	217237	10	3	4014468056550
Pz2	25	217238	10	3	4014468056567
Pz2	25	221706	100	1	4014468059773
Pz3	25	217239	10	3	4014468056574

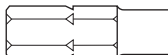

Drive ISO 1173-C6.3, 1/4" external hex shank, with reduced diameter bit drive

Classic XH version

Pz1R	25	224644	10	3	4014468064258
Pz2R	25	221707	10	3	4014468059780
Pz2R	25	221708	100	1	4014468059797

Isotemp version

Pz2R	25	221709	10	3	4014468059803
Pz2R	25	221710	100	1	4014468059810

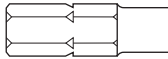

Tip	Length mm	Part number F00Y...	Sales Package qty.	Despatch package qty.	Barcode
-----	-----------	---------------------	--------------------	-----------------------	---------

Drive ISO 1173-C6.3, 1/4" external hex shank

Classic XH version

Pz1	50	221702	10	3	4014468059704
Pz2	50	221703	10	3	4014468059711
Pz3	50	221704	10	3	4014468059728

Isotemp version

Pz2	50	222407	10	3	4014468059742
-----	----	--------	----	---	---------------



Drive ISO 1173-E6.3, 1/4" external hex shank

Classic XH version

Pz1	50	216617	5	5	4014468056437
Pz2	50	216618	5	5	4014468056444
Pz2	50	221719	100	1	4014468059902
Pz3	50	216619	5	5	4014468056451

Max Grip version

Pz1	50	221720	5	5	4014468058233
Pz2	50	221721	5	5	4014468058240
Pz3	50	221722	5	5	4014468058257

Isotemp version

Pz1	50	217217	5	5	4014468056529
Pz2	50	217218	5	5	4014468056536
Pz3	50	217219	5	5	4014468056543



Drive ISO 1173-E6.3, 1/4" external hex shank, with ribbed bit surface

Classic XH version

Pz1	50	221723	5	5	4014468059919
Pz2	50	221724	5	5	4014468059926
Pz3	50	221725	5	5	4014468059933

Isotemp version

Pz1	50	221726	5	5	4014468059940
Pz2	50	221727	5	5	4014468059957
Pz3	50	221728	5	5	4014468059964



Drive ISO 1173-E6.3, 1/4" external hex shank

Impact version

Pz2	50	265012	5	5	3165140424141
-----	----	--------	---	---	---------------



Drive ISO 1173-E6.3, 1/4" external hex shank

Classic XH version

Pz1	70	221731	5	2	4014468059971
Pz2	70	221732	5	2	4014468059988
Pz2	70	221733	100	1	4014468059995
Pz3	70	221734	5	2	4014468060007



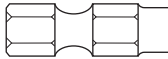

Tip	Length mm	Part number FOOY...	Sales Package qty.	Despatch package qty.	Barcode
-----	-----------	------------------------	-----------------------	--------------------------	---------



Drive ISO 1173-E6.3, 1/4" external hex shank

**Isotemp version**

Pz1	70	221735	5	2	4014468060014
Pz2	70	221737	5	2	4014468060038
Pz3	70	221736	5	2	4014468060021

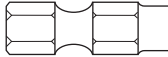

Drive ISO 1173-E6.3, 1/4" external hex shank

**Classic XH version**

Pz1	89	221738	5	2	4014468060045
Pz2	89	221739	5	2	4014468060052
Pz3	89	221740	5	2	4014468060069

**Isotemp version**

Pz1	89	221741	5	2	4014468060076
Pz2	89	221742	5	2	4014468060083
Pz3	89	221743	5	2	4014468060090

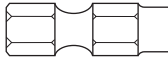

Drive ISO 1173-E6.3, 1/4" external hex shank

**Classic XH version**

Pz1	152	221747	5	1	4014468060106
Pz2	152	221748	5	1	4014468060113
Pz3	152	221749	5	1	4014468060120

**Isotemp version**

Pz1	152	265015	5	1	3165140424172
Pz2	152	221751	5	1	4014468060144

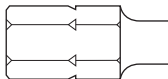

Drive ISO 1173-C8, 5/16" external hex shank

**Classic XH version**

Pz1	32	221711	5	5	4014468059827
Pz2	32	221712	5	5	4014468059834
Pz3	32	221713	5	5	4014468059841
Pz4	32	221714	5	5	4014468059858

**Isotemp version**

Pz3	32	265019	5	5	3165140424219
-----	----	--------	---	---	---------------

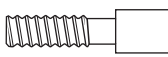

Drive M5 threaded

**Classic XH version**

Pz1	45	221753	5	1	4014468060168
Pz2	45	221754	5	1	4014468060175
Pz2	45	221755	5	1	4014468060182

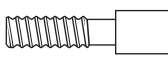

Drive 10/32" threaded

**Classic XH version**

Pz2	45	221756	5	1	4014468060199
-----	----	--------	---	---	---------------

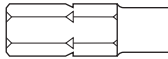

Tip	Length mm	Part number F00Y...	Sales Package qty.	Despatch package qty.	Barcode
-----	-----------	---------------------	--------------------	-----------------------	---------

Drive ISO 1173-C6.3, 1/4" external hex shank

Classic XH version

Ph0	25	221759	10	3	4014468058332
Ph0	25	221760	100	1	4014468058349
Ph1	25	216559	10	3	4014468056598
Ph1	25	224645	100	1	4014468064265
Ph2	25	216561	10	3	4014468056604
Ph2	25	224646	100	1	4014468064272
Ph3	25	216563	10	3	4014468056611
Ph3	25	224647	100	1	4014468064289
Ph4	32	221767	5	3	4014468058417

Max Grip+ version

Ph1	25	221768	10	3	4014468058424
Ph2	25	221769	10	3	4014468058431
Ph2	25	221770	100	1	4014468058448
Ph3	25	221771	10	3	4014468058455

Isotemp version

Ph0	25	265277	10	3	3165140531276
Ph1	25	217190	10	3	4014468056642
Ph2	25	217191	10	3	4014468056659
Ph2	25	221774	100	1	4014468060205
Ph3	25	217192	10	3	4014468056666

Magnator XH+ version

Ph1	25	221761	10	3	4014468058356
Ph1	25	221762	100	1	4014468058356
Ph2	25	221763	10	3	4014468058370
Ph2	25	221764	100	1	4014468058387
Ph3	25	221765	10	3	4014468058394
Ph3	25	221766	100	1	4014468058400

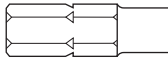

Drive ISO 1173-C6.3, 1/4" external hex shank, with ribbed surface

Classic XH version

Ph1	25	217255	10	3	4014468056703
Ph2	25	217257	10	3	4014468056710
Ph2	25	221783	100	1	4014468060281
Ph3	25	221784	10	3	4014468060298

Isotemp version

Ph1	25	221785	10	3	4014468060304
Ph2	25	221786	10	3	4014468060311
Ph3	25	221787	10	3	4014468060328

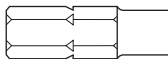

Drive ISO 1173-C6.3, 1/4" external hex shank, with reduced diameter bit drive

Classic XH version

Ph1R	25	221788	10	3	4014468060335
Ph1R	25	221789	100	1	4014468060342
Ph2R	25	221790	10	3	4014468060359
Ph2R	25	221791	100	1	4014468060366

Isotemp version

Ph2R	25	221793	10	3	4014468060380
------	----	--------	----	---	---------------

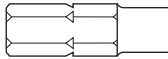

Tip	Length mm	Part number FOOY...	Sales Package qty.	Despatch package qty.	Barcode
-----	-----------	------------------------	-----------------------	--------------------------	---------

Drive ISO 1173-C6.3, 1/4" external hex shank, with reduced diameter bit drive

Classic XH version	Ph1R	50	221794	5	3	4014468060397
	Ph2R	50	221795	5	3	4014468060403

Classic XH version	Ph2R	76	221796	5	1	4014468060410
--------------------	------	----	--------	---	---	---------------

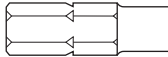

Drive ISO 1173-C6.3, 1/4" external hex shank

Classic XH version	Ph2	38	221777	10	3	4014468060229
--------------------	-----	----	--------	----	---	---------------

Classic XH version	Ph1	50	221776	10	3	4014468060212
	Ph2	50	221778	10	3	4014468060236
	Ph3	50	221780	10	3	4014468060250

Classic XH version	Ph2	64	221779	10	3	4014468060243
--------------------	-----	----	--------	----	---	---------------



Drive ISO 1173-E6.3, 1/4" external hex shank

Classic XH version	Ph0	50	217123	5	5	4014468056772
	Ph1	50	216608	5	5	4014468056727
	Ph2	50	216609	5	5	4014468056734
	Ph2	50	221809	100	1	4014468060526
	Ph3	50	216610	5	5	4014468056741

Max Grip version	Ph1	50	221810	5	5	4014468058486
	Ph2	50	221811	5	5	4014468058493
	Ph3	50	221812	5	5	4014468058509

Isotemp version	Ph0	50	265278	5	5	3165140531283
	Ph1	50	216804	5	5	4014468056758
	Ph2	50	217290	5	5	4014468056789
	Ph2	50	221813	100	1	4014468060533
	Ph3	50	216805	5	5	4014468056765



Drive ISO 1173-E6.3, 1/4" external hex shank

Classic XH version	Ph1	50	221814	5	5	4014468060540
	Ph2	50	221815	5	5	4014468060557
	Ph3	50	221816	5	5	4014468060564

Isotemp version	Ph1	50	221817	5	5	4014468060571
	Ph2	50	221818	5	5	4014468060588
	Ph3	50	221819	5	5	4014468060595

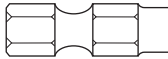

Tip	Length mm	Part number FOOY...	Sales Package qty.	Despatch package qty.	Barcode
-----	-----------	------------------------	-----------------------	--------------------------	---------

Drive ISO 1173-E6.3, 1/4" external hex shank, with ribbed surface

**Classic XH version**

Ph1	50	221820	5	5	4014468060601
Ph2	50	221821	5	5	4014468060618
Ph3	50	221822	5	5	4014468060625

**Isotemp version**

Ph1	50	221823	5	5	4014468060632
Ph2	50	221824	5	5	4014468060649
Ph3	50	221825	5	5	4014468060656

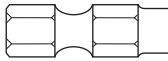

Drive ISO 1173-E6.3, 1/4" external hex shank

**Classic XH version**

Ph1	70	221826	5	2	4014468060663
Ph2	70	221827	5	2	4014468060670
Ph2	70	221828	100	1	4014468060687
Ph3	70	221829	5	2	4014468060694

**Isotemp version**

Ph1	70	265279	5	2	3165140531290
Ph2	70	221831	5	2	4014468060717
Ph3	70	265280	5	2	3165140531306

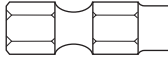

Drive ISO 1173-E6.3, 1/4" external hex shank

**Classic XH version**

Ph1	89	222394	5	2	4014468060731
Ph2	89	222395	5	2	4014468060748
Ph2	89	222396	100	1	4014468060755
Ph3	89	221833	5	2	4014468060762

**Isotemp version**

Ph1	89	221834	5	2	4014468060779
Ph2	89	221835	5	2	4014468060786
Ph3	89	221836	5	2	4014468060793

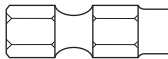

Drive ISO 1173-E6.3, 1/4" external hex shank

**Classic XH version**

Ph1	102	221837	5	1	4014468060809
Ph2	102	221838	5	1	4014468060816
Ph2	102	221839	100	1	4014468060823
Ph3	102	221840	5	1	4014468060830

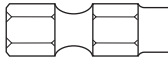

Tip	Length mm	Part number F00Y...	Sales Package qty.	Despatch package qty.	Barcode
-----	-----------	---------------------	--------------------	-----------------------	---------



Drive ISO 1173-E6.3, 1/4" external hex shank

**Classic XH version**

Ph1	152	221844	5	1	4014468060847
Ph2	152	221845	5	1	4014468060854
Ph3	152	221846	5	1	4014468060861

**Isotemp version**

Ph2	152	221848	5	1	4014468060885
-----	-----	--------	---	---	---------------

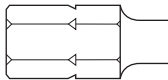

Drive ISO 1173-C8, 5/16" external hex shank

**Classic XH version**

Ph1	32	221797	5	5	4014468060427
Ph2	32	221798	5	5	4014468060434
Ph3	32	221799	5	5	4014468060441
Ph4	32	221800	5	5	4014468060458

**Isotemp version**

Ph2	32	265020	5	5	3165140424226
-----	----	--------	---	---	---------------

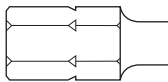

Drive ISO 1173-C8, 5/16" external hex shank, with ribbed bit surface

**Classic XH version**

Ph2	35	221805	10	2	4014468060502
-----	----	--------	----	---	---------------

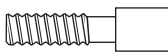

Drive M5 threaded

**Classic XH version**

Ph1	45	221852	5	1	4014468060908
Ph2	45	221853	5	1	4014468060915
Ph3	45	221854	5	1	4014468060922

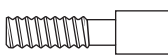

Drive 10/32" threaded

**Classic XH version**

Ph2	45	221855	5	1	4014468060939
-----	----	--------	---	---	---------------

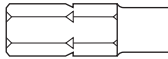

Tip	Length mm	Part number F00Y...	Sales Package qty.	Despatch package qty.	Barcode
-----	-----------	---------------------	--------------------	-----------------------	---------

Drive ISO 1173-C6.3, 1/4" external hex shank

Classic XH version

T6	25	221857	5	5	4014468060946
T7	25	221858	5	5	4014468060953
T8	25	221859	5	5	4014468060960
T9	25	221860	5	5	4014468060977
T10	25	216984	10	3	4014468056871
T10	25	221861	100	1	4014468060984
T15	25	216985	10	3	4014468056888
T15	25	221862	100	1	4014468060991
T20	25	216986	10	3	4014468056895
T20	25	221863	100	1	4014468061004
T25	25	216987	10	3	4014468056901
T25	25	221864	100	1	4014468061011
T27	25	216988	10	3	4014468056918
T27	25	221865	100	1	4014468061028
T30	25	216989	10	3	4014468056925
T30	25	221866	100	1	4014468061035
T40	25	216990	10	3	4014468056932
T40	25	221867	100	1	4014468061042

Max Grip version

T8	25	221872	5	5	4014468058578
T10	25	221873	10	3	4014468058585
T15	25	221874	10	3	4014468058592
T20	25	221875	10	3	4014468058622
T25	25	221876	10	3	4014468058622
T27	25	221877	10	3	4014468058646
T30	25	221878	10	3	4014468058653
T40	25	221879	10	3	4014468058660

Isotemp version

T10	25	216845	10	3	4014468056802
T15	25	216846	10	3	4014468056819
T20	25	216847	10	3	4014468056826
T25	25	216848	10	3	4014468056833
T27	25	216849	10	3	4014468056840
T30	25	216850	10	3	4014468056857
T40	25	216851	10	3	4014468056864



Drive ISO 1173-E6.3, 1/4" external hex shank

Classic XH version

T6	50	222055	5	5	4014468059384
T7	50	221920	5	5	4014468061196
T8	50	221921	5	5	4014468061202
T9	50	221922	5	5	4014468061219
T10	50	217017	5	5	4014468056949
T15	50	217018	5	5	4014468056956
T20	50	217019	5	5	4014468056963
T25	50	217020	5	5	4014468056970
T27	50	217021	5	5	4014468056987
T30	50	217022	5	5	4014468056994
T40	50	217023	5	5	4014468057007

Minimum order quantity per part number = Sales package quantity x despatch package quantity  
Order quantities that do not match the specified increments of the despatch quantity (e.g. 5->10->15) are automatically rounded up to the next increment.

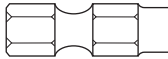

Tip	Length mm	Part number F00Y...	Sales Package qty.	Despatch package qty.	Barcode
-----	-----------	---------------------	--------------------	-----------------------	---------

Drive ISO 1173-E6.3, 1/4" external hex shank

Isotemp version

T7	50	265281	5	5	3165140531313
T8	50	265282	5	5	3165140531320
T9	50	265283	5	5	3165140531337
T10	50	217208	5	5	4014468057021
T15	50	217209	5	5	4014468057038
T20	50	217210	5	5	4014468057045
T25	50	217211	5	5	4014468057052
T27	50	217140	5	5	4014468057014
T30	50	217212	5	5	4014468057069
T40	50	218020	5	5	4014468057076

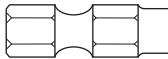

Drive ISO 1173-E6.3, 1/4" external hex shank

Classic XH version

T8	70	221941	5	2	4014468061257
T9	70	221942	5	2	4014468061264
T10	70	221943	5	2	4014468061271
T15	70	221944	5	2	4014468061288
T20	70	221945	5	2	4014468061295
T25	70	221946	5	2	4014468061318
T27	70	221947	5	2	4014468061325
T30	70	221948	5	2	4014468061332
T40	70	221949	5	2	4014468061349



Drive ISO 1173-E6.3, 1/4" external hex shank

Classic XH version

T8	89	221950	5	1	4014468061356
T9	89	221951	5	1	4014468061363
T10	89	221952	5	1	4014468061370
T15	89	221953	5	1	4014468061387
T20	89	221954	5	1	4014468061394
T25	89	221955	5	1	4014468061400
T27	89	221956	5	1	4014468061417
T30	89	221957	5	1	4014468061424
T40	89	221958	5	1	4014468061431



Drive ISO 1173-E6.3, 1/4" external hex shank

Classic XH version

T8	152	221968	5	1	4014468061530
T10	152	221969	5	1	4014468061547
T15	152	221970	5	1	4014468061554
T20	152	221971	5	1	4014468061561
T25	152	221972	5	1	4014468061578
T27	152	221973	5	1	4014468061585

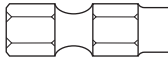

Tip	Length mm	Part number F00Y...	Sales Package qty.	Despatch package qty.	Barcode
-----	-----------	---------------------	--------------------	-----------------------	---------



Drive ISO 1173-E6.3, 1/4" external hex shank

**Classic XH version**

T 30	152	221974	5	1	4014468061592
T 40	152	221975	5	1	4014468061608

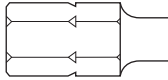

Drive ISO 1173-C8, 5/16" external hex shank

**Classic XH version**

T 30	35	221891	5	2	4014468061097
T 40	35	221892	5	2	4014468061103
T 45	35	221893	5	2	4014468061110
T 50	35	221895	5	2	4014468063978
T 55	35	221896	5	2	4014468063985

## Torxalign® (Wedge)

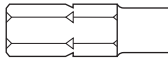

Drive ISO 1173-C6.3, 1/4" external hex shank

**Classic XH version**

T 10W	25	221980	5	1	4014468061653
T 15W	25	221981	5	1	4014468061660
T 20W	25	221982	5	1	4014468061677
T 25W	25	221983	5	1	4014468061684
T 30W	25	221985	5	1	4014468061707

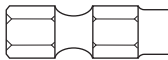

Drive ISO 1173-E6.3, 1/4" external hex shank

**Classic XH version**

T 10W	50	221990	5	1	4014468061769
T 15W	50	221991	5	1	4014468061776
T 20W	50	221992	5	1	4014468061783
T 25W	50	221993	5	1	4014468061790
T 30W	50	221995	5	1	4014468061813



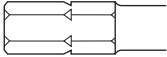

Tip	Length mm	Part number FOOY...	Sales Package qty.	Despatch package qty.	Barcode
-----	-----------	------------------------	-----------------------	--------------------------	---------

Drive ISO 1173-C6.3, 1/4" external hex shank

Classic XH version

T 7H	25	221996	5	3	4014468061820
T 8H	25	221997	5	3	4014468061837
T 9H	25	221998	5	3	4014468061844
T 10H	25	221999	5	3	4014468061851
T 15H	25	222000	5	3	4014468061868
T 20H	25	222001	5	3	4014468061875
T 25H	25	222002	5	3	4014468061882
T 27H	25	222003	5	3	4014468061899
T 30H	25	222004	5	3	4014468061905
T 40H	25	222005	5	3	4014468061912

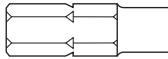

Tip	Length mm	Part number FOOY...	Sales Package qty.	Despatch package qty.	Barcode
-----	-----------	------------------------	-----------------------	--------------------------	---------

Drive ISO 1173-C6.3, 1/4" external hex shank

**Classic XH version**

S0.5x3.0	25	222060	10	3	4014468059438
S0.5x4.0	25	217156	10	3	4014468057120
S0.6x4.5	25	217157	10	3	4014468057137
S0.8x5.5	25	217158	10	3	4014468057144
S1.0x5.5	25	222009	10	3	4014468059155
S1.0x6.0	25	222010	10	3	4014468059162
S1.2x6.5	25	217160	10	3	4014468057168
S1.2x8.0	25	217161	10	3	4014468057175
S1.6x8.0	25	222013	10	3	4014468059193
S0-1	25	222027	5	5	4014468061929
S1-2	25	222028	5	5	4014468061936
S2-3	25	222029	5	5	4014468061943
S3-4	25	222030	5	5	4014468061950
S4-5	25	222031	5	5	4014468061967
S5-6	25	222032	5	5	4014468061974
S6-8	25	222033	5	5	4014468061981
S8-10	25	222034	5	5	4014468061998
S10-12	25	222035	5	5	4014468062001
S12-14	25	222036	5	5	4014468062018

**Max Grip+ version**

S0.5x4.0	25	221887	10	3	4014468058745
S0.6x4.5	25	222023	10	3	4014468059209
S0.8x5.5	25	222024	10	3	4014468059216
S1.0x5.5	25	221888	10	3	4014468058752
S1.2x6.5	25	221889	10	3	4014468058769
S1.2x8.0	25	222025	10	3	4014468059223
S1.6x8.0	25	222026	10	3	4014468059230

**Isotemp version**

S0.5x3.0	25	265292	10	3	3165140532457
S0.5x4.0	25	217226	10	3	4014468057298
S0.6x4.5	25	217227	10	3	4014468057304
S0.8x5.5	25	217220	10	3	4014468057267
S1.0x5.5	25	217221	10	3	4014468057274
S1.0x6.0	25	216773	10	3	4014468057090
S1.2x6.5	25	217222	10	3	4014468057281
S1.2x8.0	25	217228	10	3	4014468057311
S1.6x8.0	25	217229	10	3	4014468057328
S8-10	25	265017	5	5	3165140424196

**Magnator XH+ version**

S0.5x4.0	25	222006	10	3	4014468059124
S0.6x4.5	25	222007	10	3	4014468059131
S0.8x5.5	25	222008	10	3	4014468059148
S1.0x5.5	25	265634	10	3	3165140577571
S1.2x6.5	25	222011	10	3	4014468059179
S1.2x8.0	25	222012	10	3	4014468059186

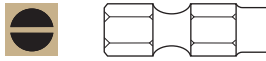

Tip	Length mm	Part number FOOY...	Sales Package qty.	Despatch package qty.	Barcode
-----	-----------	------------------------	-----------------------	--------------------------	---------

Drive ISO 1173-E6.3, 1/4" external hex shank

Classic XH version

S0.5x3.0	50	222037	5	5	4014468059247
S0.5x4.0	50	222038	5	5	4014468062025
S0.6x4.5	50	222039	5	5	4014468062032
S0.8x5.5	50	222040	5	5	4014468062056
S1.0x5.5	50	222041	5	5	4014468062063
S1.0x6.0	50	222042	5	5	4014468062087
S1.2x6.5	50	222043	5	5	4014468062094
S1.2x8.0	50	222044	5	5	4014468062100
S1.6x8.0	50	222045	5	5	4014468062117

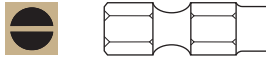

Drive ISO 1173-E6.3, 1/4" external hex shank

Classic XH version

S0.5x3.0	70	222047	5	2	4014468059308
S0.6x4.5	70	222049	5	2	4014468059322
S0.8x5.5	70	222050	5	2	4014468059339
S1.0x5.5	70	222051	5	2	4014468059346
S1.2x6.5	70	222052	5	2	4014468059353

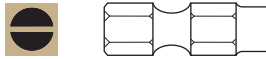

Drive ISO 1173-E6.3, 1/4" external hex shank

Classic XH version

S0.8x5.5	89	222056	5	2	4014468059391
S1.0x5.5	89	222057	5	2	4014468059407
S1.2x6.5	89	222058	5	2	4014468059414
S1.2x8.0	89	222059	5	2	4014468059421



Drive ISO 1173-E6.3, 1/4" external hex shank

Classic XH version

S6-8	89/95	265013	10	1	3165140424165
S8-10	89/95	265014	10	1	3165140424158

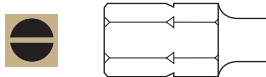

Drive ISO 1173-C8, 5/16" external hex shank

Classic XH version

S16-18	32	265018	5	1	3165140424202
--------	----	--------	---	---	---------------

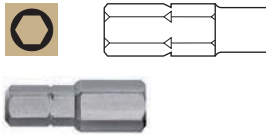

Tip	Length mm	Part number F00Y...	Sales Package qty.	Despatch package qty.	Barcode
-----	-----------	---------------------	--------------------	-----------------------	---------

Drive ISO 1173-C6.3, 1/4" external hex shank

Classic XH version

1.5	25	222071	5	5	4014468062179
2	25	222072	5	5	4014468062186
2.5	25	222073	5	5	4014468062193
3	25	222074	10	3	4014468062209
4	25	222075	10	3	4014468062216
5	25	222076	10	3	4014468062223
6	25	222077	10	3	4014468062230
7	25	222078	5	5	4014468062247
8	25	222079	5	5	4014468062254
5/64"	25	222091	5	5	4014468062384
3/32"	25	222092	5	5	4014468062391
7/64"	25	222093	5	5	4014468062407
1 / 8 "	25	222094	5	5	4014468062414
9/64"	25	222095	5	5	4014468062421
5/32"	25	222096	5	5	4014468062438
3/16"	25	222097	5	5	4014468062445
7/32"	25	222098	5	5	4014468062452
1 / 4 "	25	222099	5	5	4014468062469
5/16"	25	222100	5	5	4014468062476
3 / 8 "	25	222101	5	5	4014468062483

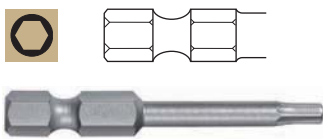

Drive ISO 1173-E6.3, 1/4" external hex shank

Classic XH version

2	50	222120	5	5	4014468062667
2.5	50	222121	5	5	4014468062674
3	50	222122	5	5	4014468062681
4	50	222123	5	5	4014468062698
5	50	222124	5	5	4014468062704
5/64"	50	265011	5	5	3165140424134

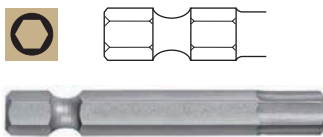

Drive ISO 1173-E6.3, 1/4" external hex shank

Classic XH version

6	50	222116	5	5	4014468062636
8	50	222118	5	5	4014468062643
10	50	222119	5	5	4014468062650

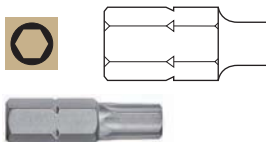

Drive ISO 1173-C8, 5/16" external hex shank

Classic XH version

3	30	222102	5	5	4014468062490
4	30	222103	5	5	4014468062506
5	30	222104	5	5	4014468062513
6	30	222105	5	5	4014468062520
7	30	222106	5	5	4014468062537
8	30	222107	5	5	4014468062544
10	30	222108	5	5	4014468062551
12	30	222109	5	5	4014468062568
14	30	222110	5	5	4014468062575

Minimum order quantity per part number = Sales package quantity x despatch package quantity  
Order quantities that do not match the specified increments of the despatch quantity (e.g. 5->10->15) are automatically rounded up to the next increment.

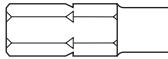

Tip	Length mm	Part number F00Y...	Sales Package qty.	Despatch package qty.	Barcode
-----	-----------	---------------------	--------------------	-----------------------	---------



Drive ISO 1173-C6.3, 1/4" external hex shank

**Classic XH version**

R0	25	222135	5	5	4014468062810
R1	25	222136	5	5	4014468062827
R2	25	222137	5	5	4014468062834
R2	25	222138	100	1	4014468062841
R3	25	222139	5	5	4014468062858

**Isotemp version**

R0	25	222140	5	5	4014468062865
R1	25	222141	5	5	4014468062872
R2	25	222142	5	5	4014468062889
R3	25	222143	5	5	4014468062896

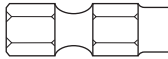

Drive ISO 1173-E6.3, 1/4" external hex shank

**Classic XH version**

R1	50	222144	5	5	4014468062902
R2	50	222145	5	5	4014468062919
R2	50	222146	100	1	4014468062926
R3	50	222147	5	5	4014468062933

**Isotemp version**

R1	50	222148	5	5	4014468062940
R2	50	222149	5	5	4014468062957
R3	50	222150	5	5	4014468062964

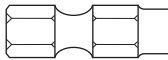

Drive ISO 1173-E6.3, 1/4" external hex shank

**Classic XH version**

R1	70	222151	5	2	4014468062971
R2	70	222152	5	2	4014468062988
R3	70	222153	5	2	4014468062995

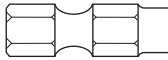

Drive ISO 1173-E6.3, 1/4" external hex shank

**Classic XH version**

R1	89	222154	5	2	4014468063015
R2	89	222155	5	2	4014468063022

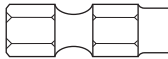

Drive ISO 1173-E6.3, 1/4" external hex shank

**Classic XH version**

R2	102	222156	5	1	4014468063053
----	-----	--------	---	---	---------------

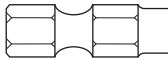

Drive ISO 1173-E6.3, 1/4" external hex shank

**Classic XH version**

R1	152	222157	5	1	4014468063060
R2	152	222158	5	1	4014468063077
R3	152	222159	5	1	4014468063084

Minimum order quantity per part number = Sales package quantity x despatch package quantity  
Order quantities that do not match the specified increments of the despatch quantity (e.g. 5->10->15) are automatically rounded up to the next increment.

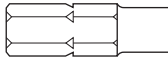

Tip	Length mm	Part number F00Y...	Sales Package qty.	Despatch package qty.	Barcode
-----	-----------	---------------------	--------------------	-----------------------	---------

Drive ISO 1173-C6.3, 1/4" external hex shank

Isotemp version

0	25	222160	5	1	4014468063091
1	25	222161	5	1	4014468063107
2	25	222162	5	1	4014468063121
3	25	222163	5	1	4014468063138
4	25	222164	5	1	4014468063145
5	25	222165	5	1	4014468063152
6	25	222166	5	1	4014468063169
8	25	222167	5	1	4014468063176
10	25	222168	5	1	4014468063183

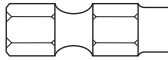

Drive ISO 1173-E6.3, 1/4" external hex shank

Isotemp version

0	32	222174	5	1	4014468063244
1	32	222175	5	1	4014468063251
2	32	222176	5	1	4014468063268
3	32	222177	5	1	4014468063275
4	32	222178	5	1	4014468063282
5	32	222179	5	1	4014468063299
6	32	222180	5	1	4014468063305
8	32	222181	5	1	4014468063312
10	32	222182	5	1	4014468063329

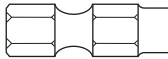

Drive ISO 1173-E6.3, 1/4" external hex shank

Isotemp version

0	50	265625	5	1	3165140576741
1	50	265626	5	1	3165140576758
2	50	265627	5	1	3165140576965
3	50	265628	5	1	3165140576772
4	50	265629	5	1	3165140576789
5	50	265630	5	1	3165140576796
6	50	265631	5	1	3165140576802
8	50	265632	5	1	3165140576819
10	50	265633	5	1	3165140576826

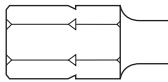

Drive ISO 1173-C8, 5/16" external hex shank

Isotemp version

1/4"	32	222171	5	1	4014468063213
5/16"	32	222172	5	1	4014468063220
3/8"	32	222173	5	1	4014468063237
10	32	224648	5	1	4014468064296

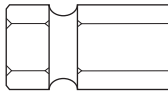

Tip	Length mm	Part number FOOY...	Sales Package qty.	Despatch package qty.	Barcode
-----	-----------	------------------------	-----------------------	--------------------------	---------

Drive ISO 1173-E11.2, 7/16" external hex shank

Isotemp version	1 / 4 "	35	222402	5	1	4014468063336
	5/16"	35	222403	5	1	4014468063343
	3/8 "	35	224649	5	1	4014468064302
	7/16"	35	222405	5	1	4014468063367

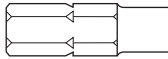

Drive ISO 1173-C6.3, 1/4" external hex shank

Isotemp version	0	25	222183	5	2	4014468063381
	1	25	222184	5	2	4014468063398
	2	25	222185	5	2	4014468063404
	3	25	222186	5	2	4014468063411
	4	25	222187	5	2	4014468063428
	5	25	222188	5	2	4014468063435
	6	32	222189	5	2	4014468063442

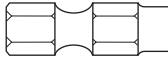

Drive ISO 1173-E6.3, 1/4" external hex shank

Isotemp version	0	50	222190	5	2	4014468063459
	1	50 <td>222191</td> <td>5 <td>2 <td>4014468063466</td> </td></td>	222191	5 <td>2 <td>4014468063466</td> </td>	2 <td>4014468063466</td>	4014468063466
	2	50 <td>222192</td> <td>5 <td>2 <td>4014468063473</td> </td></td>	222192	5 <td>2 <td>4014468063473</td> </td>	2 <td>4014468063473</td>	4014468063473
	3	50 <td>222193</td> <td>5 <td>2 <td>4014468063480</td> </td></td>	222193	5 <td>2 <td>4014468063480</td> </td>	2 <td>4014468063480</td>	4014468063480
	4	50 <td>222194</td> <td>5 <td>2 <td>4014468063497</td> </td></td>	222194	5 <td>2 <td>4014468063497</td> </td>	2 <td>4014468063497</td>	4014468063497
	5	50 <td>222195</td> <td>5 <td>2 <td>4014468063503</td> </td></td>	222195	5 <td>2 <td>4014468063503</td> </td>	2 <td>4014468063503</td>	4014468063503

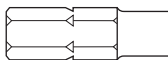

Drive ISO 1173-C6.3, 1/4" external hex shank

Isotemp version	SP 6	25	224650	5	2	4014468064371
	SP 8	25 <td>224651 <td>5 <td>2 <td>4014468064388</td> </td></td></td>	224651 <td>5 <td>2 <td>4014468064388</td> </td></td>	5 <td>2 <td>4014468064388</td> </td>	2 <td>4014468064388</td>	4014468064388
	SP10	25 <td>224652 <td>5 <td>2 <td>4014468064395</td> </td></td></td>	224652 <td>5 <td>2 <td>4014468064395</td> </td></td>	5 <td>2 <td>4014468064395</td> </td>	2 <td>4014468064395</td>	4014468064395

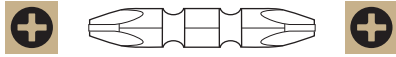

Tip, 1st bit	Tip, 2nd bit	Length mm	Part number F00Y...	Sales Package qty.	Despatch Package qty.	Barcode
--------------	--------------	-----------	---------------------	--------------------	-----------------------	---------

Double-Ended Bits 1/4"

Classic XH version	Ph2	Ph2	45	222220	10	2	4014468063589
--------------------	-----	-----	----	--------	----	---	---------------

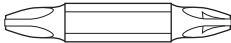
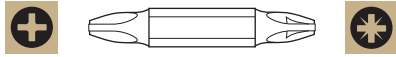

Classic XH version	Ph2	Pz2	45	222221	10	2	4014468063596
--------------------	-----	-----	----	--------	----	---	---------------

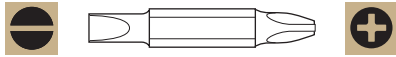

Classic XH version	S1.0x5.5	Ph2	45	222224	10	2	4014468063626
	S0.8x5.5	Ph2	60	222225	10	1	4014468063633

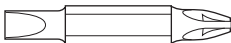
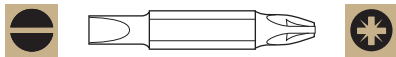

Classic XH version	S0.6x4.5	Pz1	60	222222	10	1	4014468063602
	S0.8x5.5	Pz2	60	222223	10	1	4014468063619

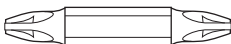
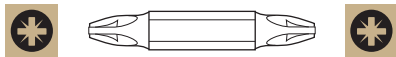

Classic XH version	Pz2	Pz2	60	222217	10	1	4014468063558
--------------------	-----	-----	----	--------	----	---	---------------

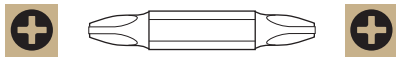

Classic XH version	Ph2	Ph2	60	222219	10	1	4014468063572
--------------------	-----	-----	----	--------	----	---	---------------



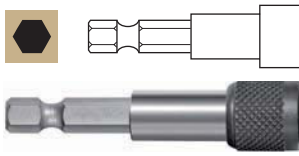

Drive Inch	Diameter mm	Part number F00Y...	Sales Package qty.	Despatch Package qty.	Barcode
------------	-------------	---------------------	--------------------	-----------------------	---------

Quick-change Bit Holder with permanent magnet

1/4"	59	14	232256	1	2	4014468071539
1/4"	75	14	265025	1	2	3165140424271

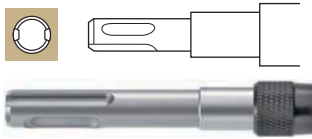

Quick-change Bit Holder with permanent magnet and SDS-plus shank

SDS-plus	79	14	232255	1	1	4014468071522
----------	----	----	--------	---	---	---------------

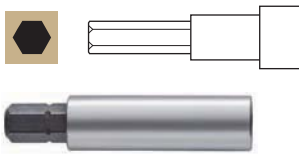

Bitholder with permanent magnet ISO 1173 C6.3

1/4"	45	10	232236	1	5	4014468071324
------	----	----	--------	---	---	---------------

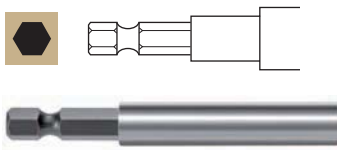

Bitholder with permanent magnet ISO 1173 E6.3

1/4"	54	9.5	232227	1	5	4014468071232
------	----	-----	--------	---	---	---------------

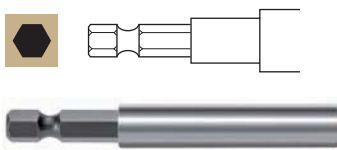

Bitholder with permanent magnet and C-ring ISO 1173 E6.3

1/4"	54	9.5	232237	1	5	4014468071331
1/4"	75	10	232234	1	5	4014468071300
1/4"	75	11	232253	1	5	4014468071508
1/4"	102	10	232242	1	1	4014468071386
1/4"	127	10	232244	1	1	4014468071409
1/4"	152	10	232245	1	1	4014468071416
1/4"	279	10	232246	1	1	4014468071423

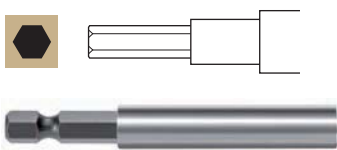

Bitholder without permanent magnet and with C-ring ISO 1173 E6.3

1/4"	54	11	232235	1	5	4014468071317
------	----	----	--------	---	---	---------------

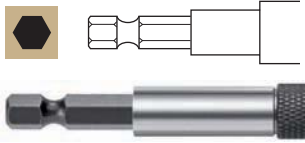

Drive Inch	Diameter mm	Part number F00Y...	Sales Package qty.	Despatch Package qty.	Barcode
------------	-------------	---------------------	--------------------	-----------------------	---------

Bitholder with permanent magnet, screw cap and O-ring ISO 1173 E6.3

1/4"	60	10	232239	1	2	4014468071355
1/4"	75	10	232238	1	2	4014468071348
1/4"	125	10	232241	1	2	4014468071379
1/4"	150	10	232243	1	2	4014468071393

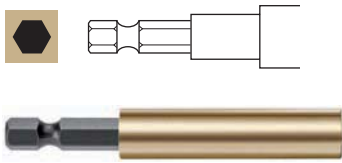

Bitholder with permanent magnet and C-ring, Silicon Bronze to prevent sparks ISO 1173 E6.3

1/4"	75	11	232249	1	2	4014468071454
------	----	----	--------	---	---	---------------

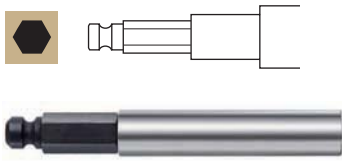

Bitholder with permanent magnet and 5/16" Desoutter shank

5/16"	75	10	232250	1	1	4014468071478
-------	----	----	--------	---	---	---------------

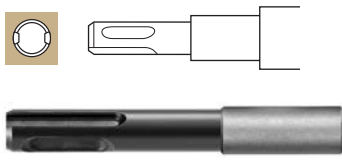

Bitholder with permanent magnet and C-ring, with SDS-plus shank

SDS-plus	98	11	232247	1	1	4014468071430
----------	----	----	--------	---	---	---------------

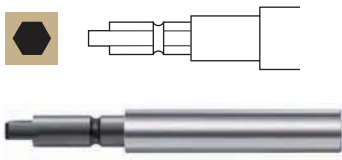

Bitholder with permanent magnet and C-ring, with ISO 1173 G7 shank

G7	75	9.5	232248	1	1	4014468071447
----	----	-----	--------	---	---	---------------

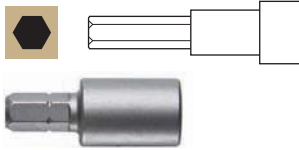

Width mm	Width inch	Length mm	Part number F00Y...	Sales Package qty.	Despatch Package qty.	Barcode
----------	------------	-----------	---------------------	--------------------	-----------------------	---------

**Nutsetters with permanent magnet ISO 1173 C6.3, 1/4" external hex shank**

7		32	232218	1	5	4014468071140
8		32	232219	1	5	4014468071157
10		32	232220	1	5	4014468071164
	1/4"	32	232214	1	5	4014468071102
	5/16"	32	232215	1	5	4014468071119
	3/8"	32	232216	1	5	4014468071126

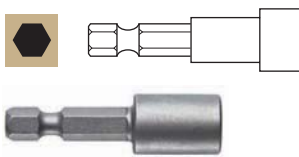

**Nutsetters with permanent magnet ISO 1173 E6.3, 1/4" external hex shank**

6		41	232208	1	5	4014468071041
5.5		45	232222	1	5	4014468071188
7		45	232217	1	5	4014468071133
8		45	232209	1	5	4014468071058
10		45	232210	1	5	4014468071065
	1/4"	45	232167	1	5	4014468070631
	5/16"	45	232168	1	5	4014468070648
	3/8"	45	232179	1	5	4014468070754

5.5		65	232158	1	5	4014468070549
6		65	232159	1	5	4014468070556
7		65	232160	1	5	4014468070563
8		65	232161	1	5	4014468070570
10		65	232162	1	5	4014468070587
12		65	232228	1	5	4014468071249
13		65	232229	1	5	4014468071256
	1/4"	65	232155	1	5	4014468070518
	5/16"	65	232156	1	5	4014468070525
	3/8"	65	232157	1	5	4014468070532
	7/16"	65	232213	1	5	4014468071096

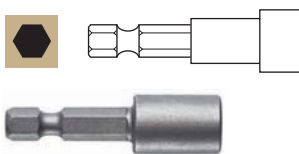

**Nutsetters without permanent magnet ISO 1173 E6.3, 1/4" external hex shank**

7		45	232176	1	5	4014468070723
8		45	232177	1	5	4014468070730
10		45	232178	1	5	4014468070747

7		65	232224	1	5	4014468071201
8		65	232225	1	5	4014468071218
10		65	232226	1	5	4014468071225
12		65	232230	1	5	4014468071263
13		65	232231	1	5	4014468071270

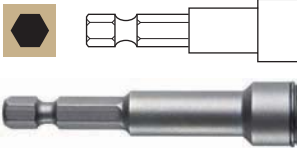

Width mm	Width inch	Length mm	Part number F00Y...	Sales Package qty.	Despatch Package qty.	Barcode
----------	------------	-----------	---------------------	--------------------	-----------------------	---------

Nutsetters with spring ISO 1173 E6.3, 1/4" external hex shank

8		65	232232	1	5	4014468071287
	3/8"	65	232233	1	5	4014468071294



Length mm	Width mm	Width Inch	External diameter	Part number F00Y...	Sales package qty.	Despatch package qty.	Barcode
-----------	----------	------------	-------------------	---------------------	--------------------	-----------------------	---------

Sockets straight with permanent magnet, 1/4" internal square

25	7		11.2	232185	1	3	4014468071003
25	8		12.2	232186	1	3	4014468070822
25	9		13.6	232187	1	3	4014468070839
25	10		14.1	232188	1	3	4014468070846
25	11		16.0	232189	1	3	4014468070853
25	12		17.3	232190	1	3	4014468070860
25	13		18.5	232191	1	3	4014468070877
25		1/4"	11.2	232212	1	3	4014468071089
25		3/8"	14.1	265253	1	3	3165140522007
25		5/16"	12.2	232166	1	3	4014468070624



Sockets straight without permanent magnet, 1/4" internal square

25	7		11.2	232197	1	3	4014468070938
25	8		12.2	232198	1	3	4014468070945
25	9		13.6	232199	1	3	4014468070952
25	10		14.1	232200	1	3	4014468070969
25	11		16.0	232201	1	3	4014468070976
25	12		17.3	232202	1	3	4014468070983
25	13		18.5	232203	1	3	4014468070990
25		1/4"	11.2	232211	1	3	4014468071072
25		3/8"	14.1	265254	1	3	3165140522014
25		5/16"	12.2	232165	1	3	4014468070617

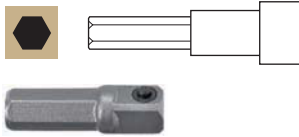

Tip	Length mm	Part number FOOY...	Sales Package qty.	Despatch package qty.	Barcode
-----	-----------	------------------------	-----------------------	--------------------------	---------

Extensions internal square drive ISO 1173-C6.3, 1/4" with pin lock

1/4"	25	232204	1	5	4014468071003
------	----	--------	---	---	---------------

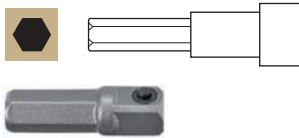

Extensions internal square drive ISO 1173-C6.3, 1/4" with ball lock

1/4"	25	232221	1	5	4014468071171
------	----	--------	---	---	---------------

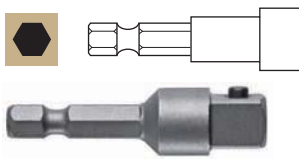

Extensions internal square drive ISO 1173-E6.3, 1/4" with pin lock

1/4"	50	232174	1	5	4014468070709
1/4"	75	232205	1	5	4014468071010
1/4"	100	232169	1	5	4014468070655
1/4"	150	232170	1	5	4014468070662
1/4"	200	232206	1	5	4014468071027
3/8"	50	232175	1	5	4014468070716
3/8"	75	232207	1	5	4014468071034

Extensions internal square drive ISO 1173-E6.3, 1/4" with ball lock

1/4"	50	232223	1	5	4014468071195
------	----	--------	---	---	---------------

Screwdrivers



Screwdrivers with magnetic bitholder

1/4"	65.5	265022	1	2	3165140424240
------	------	--------	---	---	---------------



Screwdrivers with magnetic bitholder

1/4"	190	265021	1	2	3165140424233
1/4"	280	265023	1	2	3165140424257

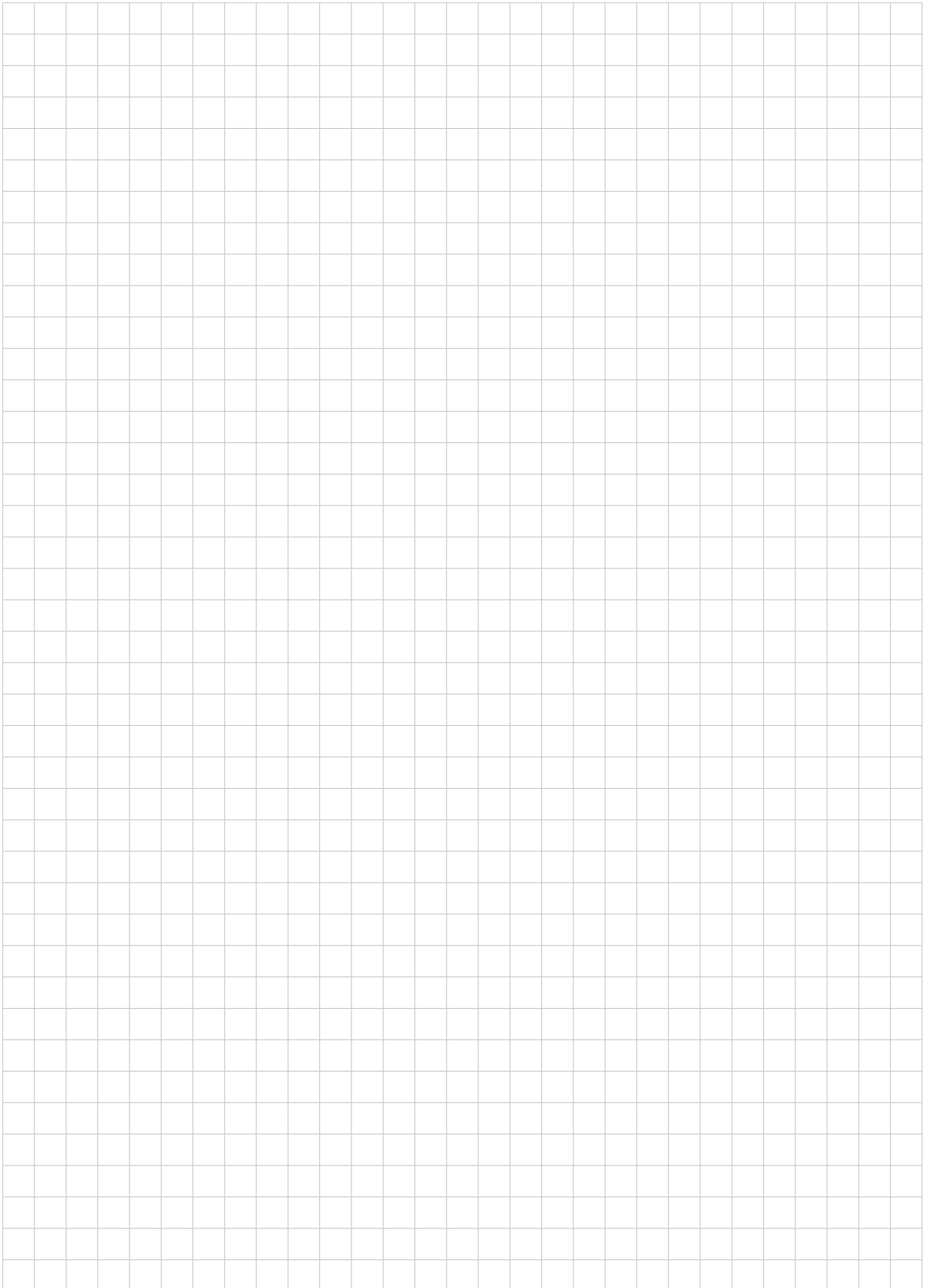

Your specialist retailer:

# MAGNA™

*Industrial Performance*

Scintilla AG  
CH-4501 Solothurn  
Switzerland  
[www.magna-ind.de](http://www.magna-ind.de)

